

Joker

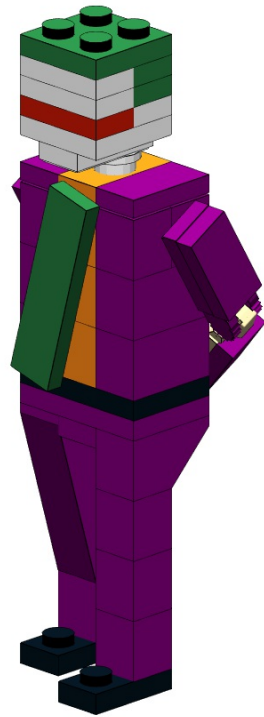

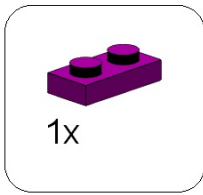

1

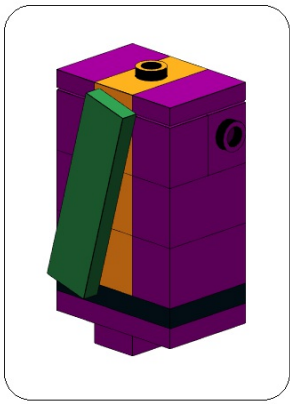
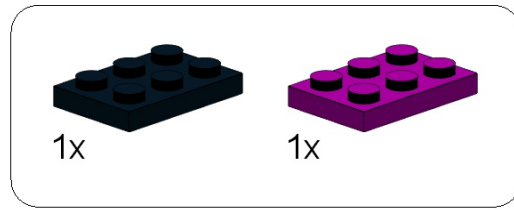
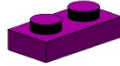

2

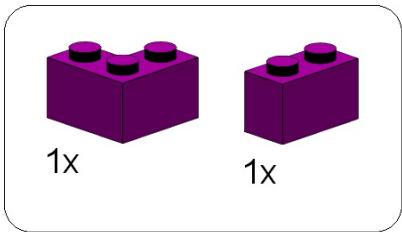
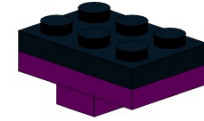

3

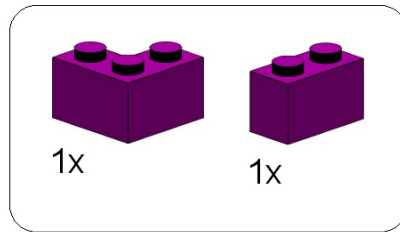
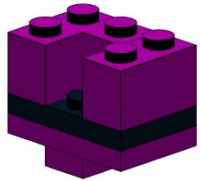

4

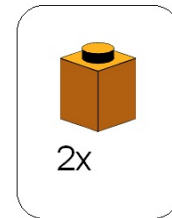
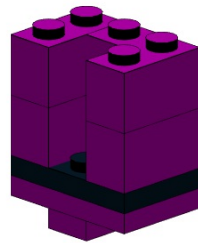

5

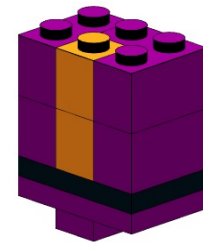

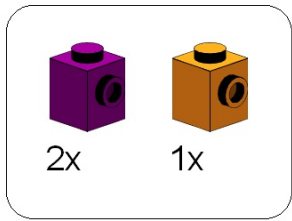

6

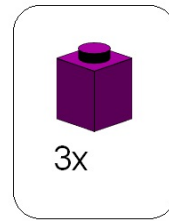
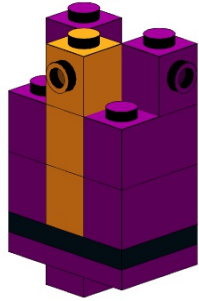

7

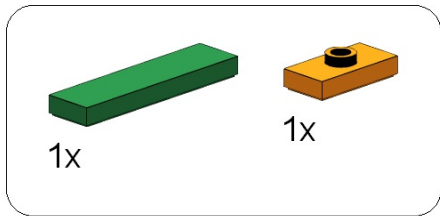
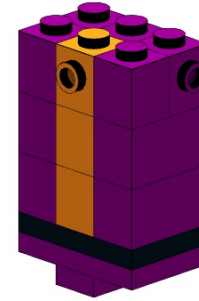

8

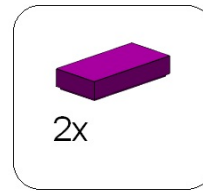
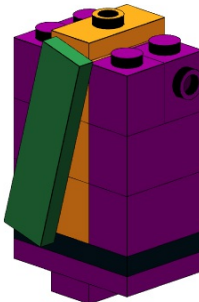

9

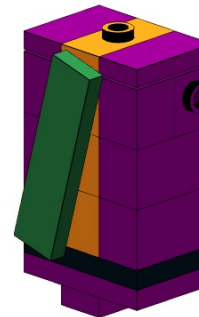

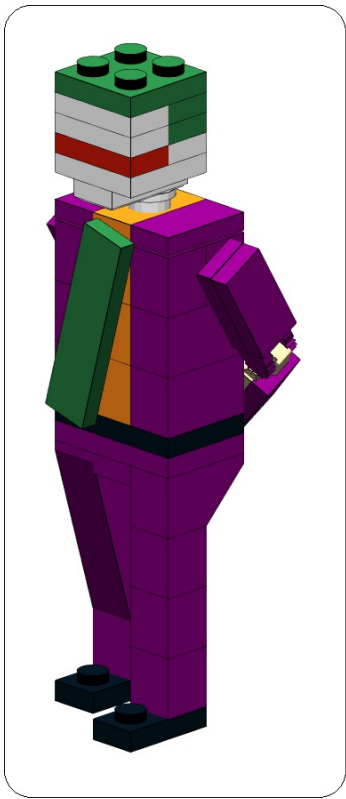

1

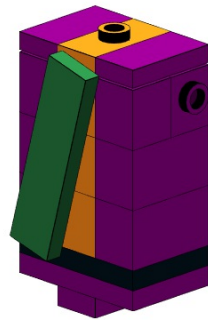

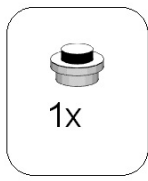
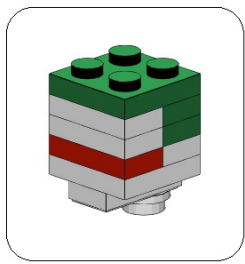

1

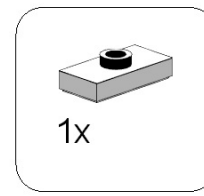

2

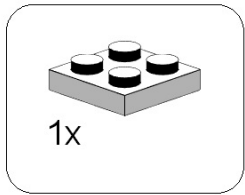
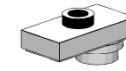

3

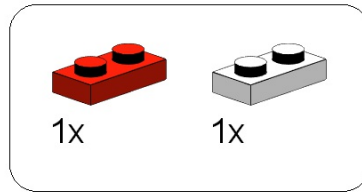
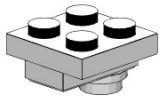

4

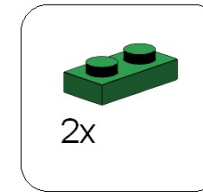
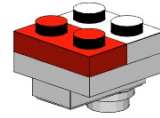

5

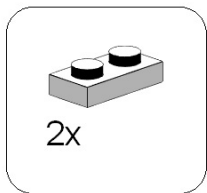
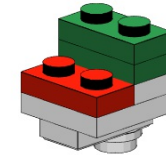

6

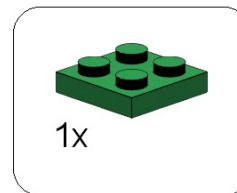
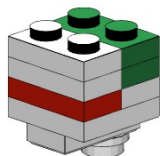

7

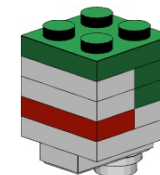

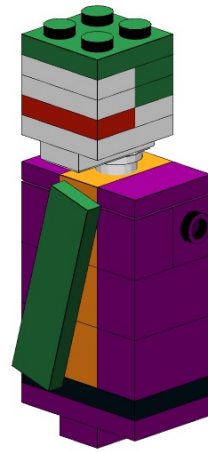

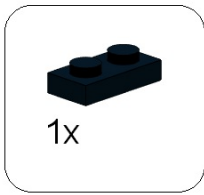
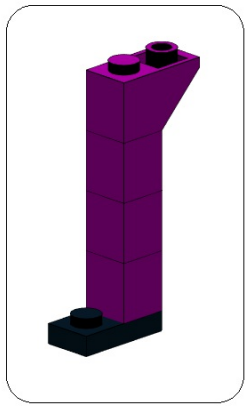

1

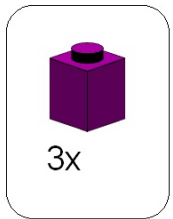

2

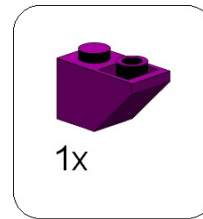
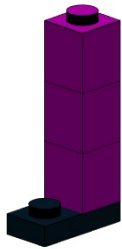

3

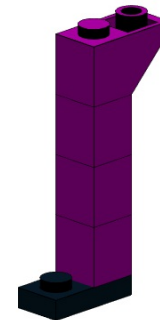

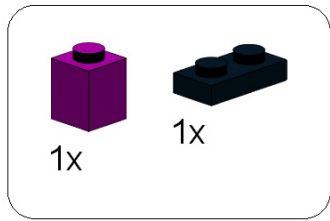
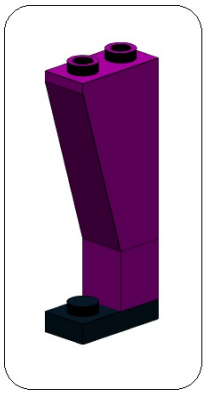

1

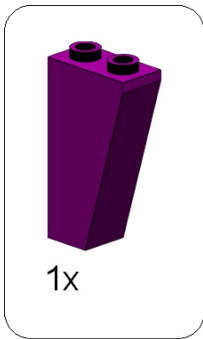
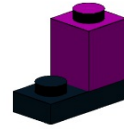

2





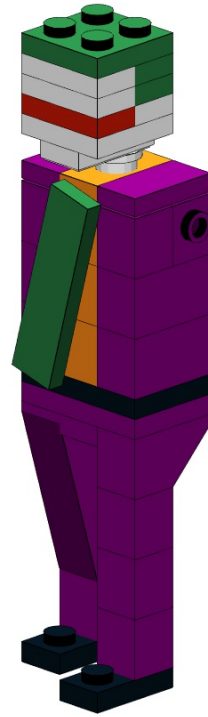

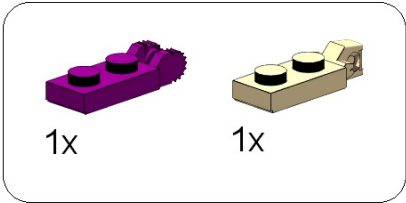
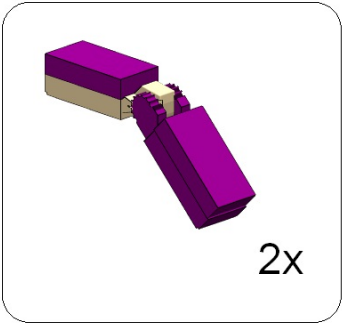

1

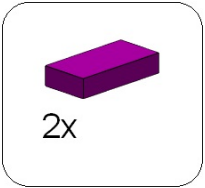
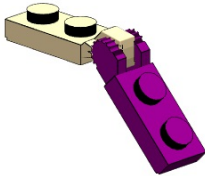

2

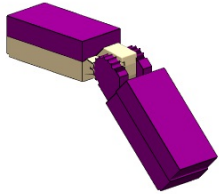

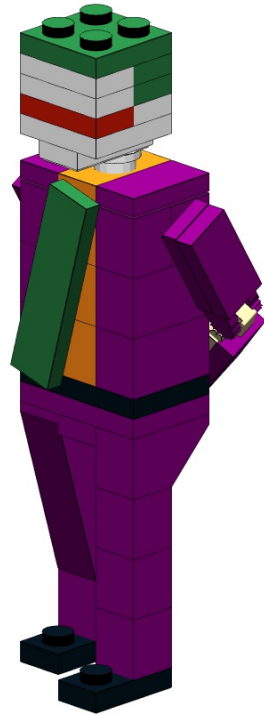



2x

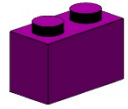

2x



2x



1x



2x



1x

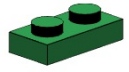

2x

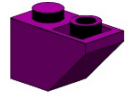

1x



1x

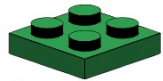

1x

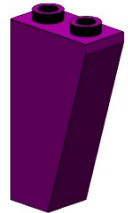

1x

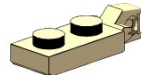

2x

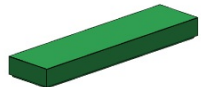

1x



1x

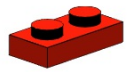

1x



4x

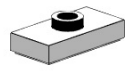

1x



2x

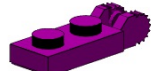

2x

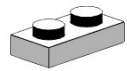

3x



7x

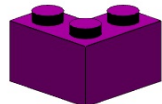

2x

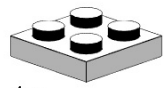

1x

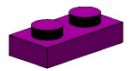

1x

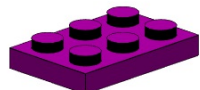

1x